



*Pure excellence. Born of uncompromising standards in manufacturing, Millett rings and bases are the strongest, most reliable, most technologically advanced in the world today. And our selection is unmatched - every product backed by one of the most knowledgeable and helpful customer service teams in the business. That's pure quality from start to finish. Millett.*



## TACTICAL RINGS

Millett® Tactical Rings are a lightweight, strong solution for the most demanding uses. Six cap-clamping screws positively hold your scope, no matter the level of recoil, and the base clamp holds the scope to the base. Millett tactical rings are your answer to any mounting needs.

ITEM	DIAMETER	HEIGHT	FINISH
DT00713	30MM	LOW	MATTE
DT00714	30MM	HIGH	MATTE
DT00715	30MM	MED	MATTE



## TACTICAL SCOPE RING W/ACCESSORY RAIL

Millett's new Tactical Accessory Mount Scope Ring lets you mount accessories above the objective of 30mm scopes. Simple Picatinny rail mount allows ease of mounting with clamping-type Weaver rings. It's positive, sure mounting for your scope and easy-to-use accessory mounting all in one.

ITEM	DESCRIPTION	DIAMETER	HEIGHT	FINISH
DT00716	W/RAIL	30MM	LOW	MATTE
DT00717	W/RAIL	30MM	MED	MATTE
DT00718	W/RAIL	30MM	HIGH	MATTE



## PICATINNY RAILS

Millett's Picatinny Rails are offered for the Remington 700 LA + SA right hand, Savage AccuTrigger LA + SA right hand and blank tactical.

Mount a wide range of optics, from red dots to large target scopes.

The rails are heat-treated T6 aluminum, black anodized with all required hardware for mounting.

ITEM	DESCRIPTION	RECEIVER	TYPE	FINISH
PC00001	REMINGTON 700	SHORT ACTION	RIGHT HAND	MATTE
PC00002	SAVAGE ACCU-TRIGGER	SHORT ACTION	RIGHT HAND	MATTE
PC00003	BLANK TACTICAL			MATTE
PC00004	REMINGTON 700	LONG ACTION	RIGHT HAND	MATTE
PC00005	SAVAGE ACCU-TRIGGER	LONG ACTION	RIGHT HAND	MATTE



## 20 MOA RAILS

Align your scope and achieve greater elevation adjustment. This Picatinny rail is configured higher in the rear than the front. Manufactured to the highest standards using lightweight, yet extremely rugged T6 aluminum.

ITEM	DESCRIPTION	RECEIVER	TYPE	FINISH
PC00009	REMINGTON 700	SHORT ACTION	RIGHT HAND	MATTE
PC00010	REMINGTON	LONG ACTION	RIGHT HAND	MATTE
PC00011	SAVAGE ACCU-TRIGGER	SHORT ACTION	RIGHT HAND	MATTE
PC00012	SAVAGE ACCU-TRIGGER	LONG ACTION	RIGHT HAND	MATTE

ITEM	DESCRIPTION	HEIGHT	FINISH
PC00016	M16/AR15 Handle Scope Mount Picatinny Rail	.625 IN.	MATTE



## GRABBER™

The Grabber is the answer for quick, easy, repeatable mounting of optics and tactical tools to Weaver, Picatinny-type rails. Manufactured with heat-treated steel, the Grabber holds tight with a 5-to-1 mechanical advantage and returns to zero every time.

ITEM	DIAMETER	HEIGHT	FINISH
GB00002	1"	MED	MATTE
GB30002	30MM	MED	MATTE



## .22 RISER RAILS

Easily mount your large objective scope, or any other optical device you like, to the top of your .22. Available in two models: choose a cut out for easy bolt action loading or rails for semi-automatics.

ITEM	DESCRIPTION	TYPE	ACTION	FINISH
RI00001	TIP OFF RISER	.22	SEMI-AUTO	MATTE
RI00002	TIP OFF RISER	.22	BOLT ACTION	MATTE



## M4 RISER RAILS

Achieve a solid hold and proper cheek position and with normal height scope rings on flattop AR, M4 and other rifle models. Riser clamps onto any Picatinny/Weaver-type base.

ITEM	DESCRIPTION	HEIGHT	FINISH
RI00003	M4 RISER	.625 IN.	MATTE



## M1A - M14 MOUNTING SYSTEM

Featuring solid T6 aluminum, improved thumb screw for easy tightening, clamping screw on the forward part of the rail to assure zero, and a positive hold and easy removal and installation, the M1A mount is strong enough for the largest scope and ready for any mission.

ITEM	DESCRIPTION	HEIGHT	FINISH
PC00014	M1a/M14 Scope Mount Picatinny Rail	.625 IN.	MATTE

## M16 HANDLE MOUNT

An easy-to-use, quick mount for scopes and sights, this Picatinny rail's extended length allows for a wide range of mounting options. Made with strong T6 aluminum, this precision-machined rail ensures only the best accuracy.



# THE MOST RIGID RING-TO-BASE CONNECTION AVAILABLE

## TURN-IN STEEL RINGS

Millett® scope mounts are the highest quality rings and bases available. They're custom crafted in heat-treated nickel-steel with all excess weight removed. This performance also has style, featuring many of Millett's unique designs.



SMOOTH

ENGRAVED

NICKEL

MATTE

## ULTRA LIGHT TWO-PIECE BASES

Our Two-Piece bases are rock-solid, easy to install, and the lightest you'll find. These precision-fit parts provide maximum ejection port clearance and have 30-50% less weight.



## STANDARD EXTENSION RINGS

This unique, solid one-piece ring provides the most durable and reliable hold available today – proof that Millett makes the best rings around.

### Standard Extension Rings

ITEM	DIAMETER	DESCRIPTION	FINISH
EX00001	1"	STD R EXT F	Smooth
EX00002	1"	EXT R EXT F	Smooth
EX00003	1"	EXT R EXT F	Smooth
EX00004	1"	STD R EXT F	Smooth
EX00005	1"	EXT R EXT F	Smooth
EX00006	1"	EXT R EXT F	Smooth
EX00008	30MM	EXT R EXT F	Smooth

### Turn-In Standard Rings

RING	A-HEIGHT	B-HEIGHT	C-HEIGHT	D-HEIGHT	E-HEIGHT	F-HEIGHT
1"	.145	.265	.395	.500	.265	.395
30MM	.206	.350	.495		.350	.495

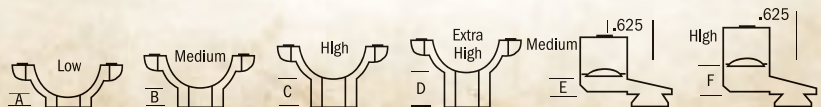

### Turn-In Standard Rings

ITEM	DESCRIPTION	HEIGHT	FINISH
SR00001	1"	Low	Smooth
SR00002	1"	Med	Smooth
SR00003	1"	High	Smooth
SR00008	1"	Extra High	Smooth
SR00701	1"	Low	Matte
SR00702	1"	Med	Matte
SR00703	1"	High	Matte
SR00708	1"	Extra High	Matte
SR00901	1"	Low	Nickel
SR00902	1"	Med	Nickel
SR00903	1"	High	Nickel
SR00908	1"	Extra High	Nickel
ER00001	1"	Low	Engraved
ER00002	1"	Med	Engraved
ER00003	1"	High	Engraved
SR00004	30MM	Low	Smooth
SR00005	30MM	Med	Smooth
SR00006	30MM	High	Smooth
SR00704	30MM	Low	Matte
SR00705	30MM	Med	Matte
SR00706	30MM	High	Matte

### Turn-In Two Piece Bases

ITEM	DESCRIPTION	FINISH
<b>Browning</b>		
BB00005	A-Bolt	Smooth
BB00705	A-Bolt	Matte
BB00905	A-Bolt	Nickel
BB00004	BLR, BAR	Smooth
<b>FN Mauser Series, Interarms</b>		
FN00002	FN Series, Interarms Mark X	Smooth
FN00003	Mauser 96	Smooth
<b>Kimber of America</b>		
KM00001	Kimber Model 82C & 84C	Smooth
Marlin		
MB00007	336	Smooth
<b>Remington, Weatherby</b>		
SB70001	REM 700 Series, Weatherby	Smooth
SB70701	REM 700 Series, Weatherby	Matte
SB70901	REM 700 Series, Weatherby	Nickel
RB00006	REM 7400, 7600, 4, 6, AMT	Smooth
RB00906	REM 7400, 7600, 4, 6, AMT	Nickel
RB00007	REM 740, 742, 760	Smooth
RB00907	REM 740, 742, 760	Nickel
<b>Savage</b>		
SB00009	110, 111, 112, 114, 116	Smooth
SB00709	110, 111, 112, 114, 116	Matte
SB00909	110, 111, 112, 114, 116	Nickel
<b>Winchester &amp; Marlin MR-7</b>		
WB70003	70 Series	Smooth
WB70703	70 Series	Matte
WB70903	70 Series	Nickel
WB00008	94, Angle-Eject	Smooth



## ANGLE-LOC™ WINDAGE ADJUSTABLE WEAVER-STYLE RINGS

The Angle-Loc windage-adjustable scope mount system is the most significant improvement to the traditional Weaver-Style mount in many years. Adjust your scope side to side for precise alignment to your receiver. All components are made of heat-treated nickel-steel for rock-solid durability.



SMOOTH

ENGRAVED

NICKEL

MATTE

### Angle-Loc Windage Adjustable Rings

ITEM	DIAMETER	DESCRIPTION	FINISH
AL00010	1"	Low	Smooth
AL00011	1"	Medium	Smooth
AL00012	1"	High	Smooth
AL00710	1"	Low	Matte
AL00711	1"	Medium	Matte
AL00712	1"	High	Matte
AL00722	1"	Extra High AR-15 Flat Top	Matte
AL00722	1"	Extra High (1.025)	Matte
AL00910	1"	Low	Nickel
AL00911	1"	Medium	Nickel
AL00912	1"	High	Nickel
AL00007	1"	Low	Engraved
AL00008	1"	Medium	Engraved
AL00009	1"	High	Engraved
AL00016	30MM	Low	Smooth
AL00017	30MM	Med	Smooth
AL00018	30MM	High	Smooth
AL00716	30MM	Low	Matte
AL00717	30MM	Med	Matte
AL00718	30MM	High	Matte
AL00917	30MM	Med	Nickel

### Angle-Loc Windage Adjustable .22 Caliber Scope Rings

ITEM	DIAMETER	DESCRIPTION	FINISH
TP00001	1"	Low	Smooth
TP00002	1"	Med	Smooth
TP00005	1"	High	Smooth
TP00701	1"	Low	Nickel
TP00702	1"	Med	Nickel
TP00705	1"	High	Nickel
TP00003	11MM	Med	Matte
TP00006	11MM	High	Matte
TP00713	1"	Med	Matte
TP00714	1"	High	Matte
TP00715	30MM	High	Matte

### Angle-Loc Windage Adjustable Ruger Scope Rings

ITEM	DIAMETER	DESCRIPTION	FINISH
RR77004	1"	Med	Smooth
RR77005	1"	High	Smooth
RR77006	30MM	Med	Smooth
RR77007	30MM	High	Smooth
RM00011	1"	High	Smooth

### Angle-Loc Windage Adjustable Ruger 10/22 Scope Rings

ITEM	DIAMETER	DESCRIPTION	FINISH
Rings Fit Factory Supplied Base For Ruger 10/22, 96/22			Smooth
RM00026	1"	Med	Smooth
Rings Fit Weaver To-9 Base For Ruger 10/22, 96/22			Smooth
RM00021	1"	Med	Smooth
RM00011	1"	High	Smooth

### Angle-Loc Windage Adjustable Sako Scope Rings

ITEM	DIAMETER	DESCRIPTION	FINISH
SA00010	1"	Low	Smooth
SA00011	1"	Med	Smooth
SA00012	1"	High	Smooth
SA00022	30MM	Med	Smooth
SA00023	30MM	High	Smooth

### Angle-Loc Windage Adjustable Tikka Scope Rings

ITEM	DIAMETER	DESCRIPTION	FINISH
TK00001	1"	Low	Matte
TK00002	1"	Med	Matte
TK00003	1"	High	Matte
TK00006	30MM	Low	Matte
TK00007	30MM	Med	Matte
TK00008	30MM	High	Matte

### Angle-Loc Windage Adjustable C2/BRND Scope Rings

ITEM	DIAMETER	DESCRIPTION	FINISH
CZ-527			
BN00001	1"	Low	Matte
BN00002	1"	Med	Matte
BN00003	1"	High	Matte
BN00006	30MM	Low	Matte
BN00007	30MM	Med	Matte
BN00008	30MM	High	Matte
ZKM-611, 452			
BN00010	1"	Med	Matte
BN00011	1"	High	Matte
ZK-600, 601, 602, CZ-550			
BN00016	1"	Med	Matte
BN00017	1"	High	Matte
BN00019	30MM	Med	Matte
BN00020	30MM	High	Matte
CZ-452 "European"			
BN00022	1"	Med	Matte
BN00023	1"	High	Matte

RINGS AND BASES

# THE WORLD'S STRONGEST TWO-PIECE BASE

## ANGLE-LOC™ STEEL TWO-PIECE BASES

These two-piece bases are the perfect match for our very popular Angle-Loc rings. Millett two-piece steel bases are 30 to 50 percent lighter than other brands. We've removed any excess weight without sacrificing strength.

- Exclusive interlocking alignment guides.
- Less ring gap for cleaner lines and a stronger mount.
- Millett Angle-Loc clamping system is windage adjustable and rock-solid.
- Recoil-proof magnum splines prevent scope slippage and dampen vibrations.



### WORLD'S STRONGEST LIGHT WEIGHT BASES.

### All-Steel Angle-Loc Two-Piece Bases

MAKE/MODEL	ITEM	FINISH
Browning A-Bolt WSM	ST00002	Smooth
Browning A-Bolt WSM	ST00702	Matte
Browning A-Bolt WSM	ST00902	Nickel
Browning A-Bolt WSSM	ST00016	Smooth
Interarms MK X, FN Mauser 98, Parker Hale	ST00004	Smooth
CVA Octagon	ST00005	Smooth
	ST00905	Nickel
Knight MK-85	ST00007	Smooth
Knight MK-86	ST00907	Nickel
Knight Wolverine	ST00008	Smooth
	ST00908	Nickel
Remington 700, Weatherby MK V, Vanguard	ST00009	Smooth
	ST00709	Matte
	ST00909	Nickel
Remington 7400/7600	ST00017	Smooth
Savage 110	ST00010	Smooth
	ST00710	Matte
	ST00910	Nickel
Savage 110 Accu-Trigger	ST00015	Smooth
	ST00715	Matte
	ST00915	Nickel
Savage 110 Accu-Trigger Combo Angle-Loc™ High	CP50703	Smooth
CP50703	Matte	
Winchester 70, 70 WSM	ST00011	Smooth
	ST00711	Matte
	ST00911	Nickel
Winchester 70 WSSM	ST00018	Smooth



### ANGLE-LOC WINDAGE ADJUSTABLE SCOPE EXTENSIONS



## ANGLE-LOC WINDAGE ADJUSTABLE EXTENSION RINGS

The easiest way to bring your scope to zero, Angle-Loc Windage Adjustable Extension Rings are the most ruggedly durable way to precisely align your scope with your receiver. Made of heat-treated nickel-steel, these rings can withstand anything you put them through.

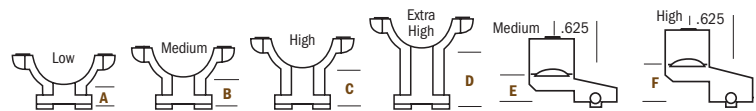

### Aluminum Detachable Rings

RING	A-HEIGHT	B-HEIGHT	C-HEIGHT	D-HEIGHT	E-HEIGHT	F-HEIGHT
Angle-Loc 1 IN.	.275	.395	.525	1.017	.395	.525
Angle-Loc 30 MM	.319	.482	.626	-	.477	.622
.22 CAL 1 IN.	.290	.420	.594	-	-	-
.22 CAL 30 MM	-	.422	-	-	-	-
RUGER M77 1 IN.	-	R-.586 F-.473	R-.699 F-.586	-	-	-
RUGER M77 30 MM	-	R-.510 F-.397	R-.623 F-.510	-	-	-
SAKO 1 IN.	.412	.532	.662	-	.532	-
SAKO 30 MM	.347	.614	.759	-	-	-
TIKKA 1 IN.	.473	.586	.724	-	-	-
TIKKA 30 MM	.395	.508	.621	-	-	-
BRNO CZ, ZKM 1IN.	.473	.586	.724	-	-	-
BRNO CZ,ZKM30MM	.395	.508	.621	-	-	-
BRNO ZKK 1 IN.	.345	.460	.590	-	-	-
BRNO ZKK 30 MM	.404	.550	.698	-	-	-

### Angle-Loc Windage Adjustable Extension Rings

ITEM	DIAMETER	DESCRIPTION	FINISH
EX25001	1"	Med (1 Ext 1 Std)	Smooth
EX25003	1"	Med (2 Ext)	Smooth
EX25004	1"	High (1 Ext 1 Std)	Smooth
EX25006	1"	High (2 Ext)	Smooth
EX25007	30MM	Med (1 Ext 1 Std)	Smooth
EX25008	30MM	Med (2 Ext)	Smooth
EX25009	30MM	High (1 Ext 1 Std)	Smooth
EX25010	30MM	High (2 Ext)	Smooth

### AR-15 Flat Top

ITEM	DESCRIPTION	WIDTH	HEIGHT	FINISH
AL00722	AR-15 Flat Top Rings	1.025	High	Matte

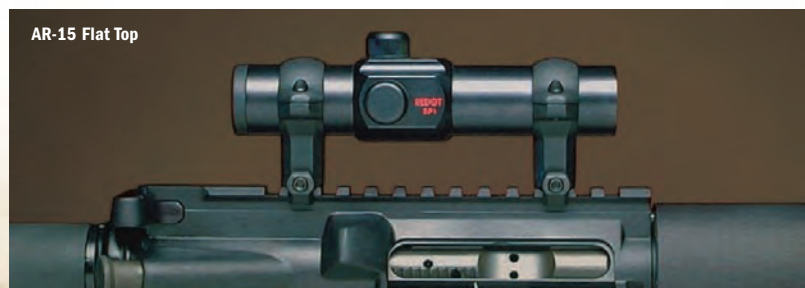

## ALUMINUM DETACHABLE RINGS

The new Angle-Loc Detachable scope mount system provides the same removable feature as the traditional Weaver-style mount. These rings have all excess weight removed to provide a slim new look, but are performance guaranteed to withstand the toughest field conditions.

- Lightweight 100% aircraft quality aluminum
- Coin slots for easy removal and installation
- The Angle-Loc clamping system provides a rock-solid mounting with normal finger pressure on the clamp cross-bolt.
- Available in three finishes - bright, silver, and matte

## ALUMINUM DETACHABLE BASES

Made to give your Angle-Loc Detachable Aluminum Rings a solid base and a firm mount to your firearm without adding unnecessary weight. Options include both one-and two-piece models.

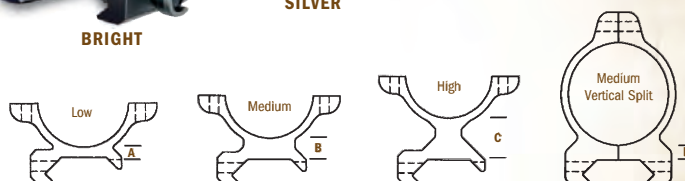

Aluminum Detachable Rings

ITEM	DIAMETER	DESCRIPTION	FINISH
DT00001	1"	Low	Bright
DT00002	1"	Med	Bright
DT00003	1"	High	Bright
DT00701	1"	Low	Matte
DT00702	1"	Med	Matte
DT00703	1"	High	Matte
DT00901	1"	Low	Silver
DT00902	1"	Med	Silver
DT00903	1"	High	Silver
DT00704	30MM	Low	Matte
DT00705	30MM	Med	Matte
DT00706	30MM	High	Matte
DT00708	.22 Cal.	Med	Matte
DT00709	.22 Cal.	High	Matte
DT00908	.22 Cal.	Med	Silver
DT00909	.22 Cal.	High	Silver

Now available in all three finishes

Made of 100% aircraft grade aluminum alloy

Bases are precision fit and won't move under heavy recoil

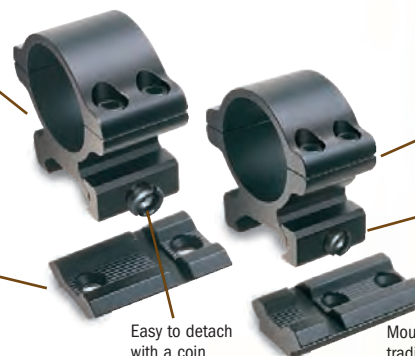

Easy to detach with a coin

Less ring gap for cleaner lines and a stronger mount

Millett Angle-Loc clamping system is rock solid and detachable

Mounting screws are stronger than traditional Weaver-style bases

Aluminum Vertical Split Rings

ITEM	DIAMETER	DESCRIPTION	FINISH
AL00019	1"	Med	Bright
AL00719	1"	Med	Matte
AL00919	1"	Med	Silver
AL00020	30MM	Med	Bright
AL00720	30MM	Med	Matte
TP00709	1"	Med	Matte
TP00710	30MM	Med (.22 Cal)	Matte

Aluminum Alloy Two-Piece Bases

ITEM	BRAND(S)	MODEL	FINISH
BB00715	Browning	A-Bolt	Matte
BB00716	Browning	BLR, BAR	Matte
FN00705	FN Mauser, Interarms	Mark X	Matte
KN00701	Knight	MK-85	Matte
SB70710	Remington	700 Series	Matte
WB70706	Winchester & Marlin	70 Series & MR-7	Matte
SB00710	Savage	110	Matte

Aluminum Alloy One-Piece Bases

ITEM	BRAND(S)	MODEL	FINISH
MB00708	Marlin	336, 30AS Series	Matte
RB00707	Remington	7400, 7600, 4, 6	Matte
RB00708	Remington	740, 742, 760, SAV170	Matte
RU00701	Ruger	10/22	Matte
SB70710	Remington	700 Series	Matte
WB70706	Winchester & Marlin	70 Series & MR-7	Matte
SB00710	Savage	110	Matte

Angle-Loc Detachable  
**1 IN. SCOPE RINGS**  
**VERTICAL SPLIT SCOPE RINGS**  
 Vertical Split  
**.22 CALIBER SCOPE RINGS**  
 Aluminum Alloy

**ONE-PIECE BASES**  
 Aluminum Alloy  
**ONE-PIECE BASES**  
**DETACHABLE COMBO PAKS**



**Combo Paks**  
 See page 116 for a complete listing.

# MILLETT COMBO PACKS

## TURN-IN TWO-PIECE BASE COMBO PAKS - INCLUDES RINGS AND BASE SET

ITEM	DIAMETER	HEIGHT	FINISH	DESCRIPTION
CP00018	1"	Medium	Smooth	Browning A-Bolt
CP00718	1"	Medium	Matte	Browning A-Bolt
CP00014	1"	Medium	Smooth	Browning BAR/BLR
CP00006	1"	Medium	Smooth	FN Mauser
CP00026	1"	Medium	Smooth	Marlin 336
CP00002	1"	Medium	Smooth	Remington 700
CP00702	1"	Medium	Matte	Remington 700 Series
CP20002	1"	High	Smooth	Remington 700 Series
CP00022	1"	Medium	Smooth	Remington 74, Sig AMT
CP00034	1"	Medium	Smooth	Savage 110
CP00734	1"	Medium	Matte	Savage 110
CP50703	1"	High	Matte	Savage 110 Accu-Trigger
CP00710	1"	Medium	Matte	Winchester 70



## ALUMINUM DETACHABLE COMBO PAKS

ITEM	DIAMETER	HEIGHT	FINISH	DESCRIPTION
CP40712	1"	Medium	Matte	Browning A-Bolt
CP40714	1"	Medium	Matte	Browning BAR/BLR
CP40716	1"	Medium	Matte	FN Mauser
CP40706	1"	Medium	Matte	Marlin
CP40702	1"	Medium	Matte	Remington 700 Series
CP40704	1"	Medium	Matte	Remington 7400
CP40728	1"	Medium	Matte	Remington 740
CP40726	1"	Medium	Matte	Ruger 10/22
CP40708	1"	Medium	Matte	Savage 110
CP40908	1"	Medium	Silver	Savage 110
CP40730	1"	Medium	Matte	Winchester 70
CP50703	1"	High	Matte	Savage 110 Accu-Trigger
CP00710	1"	Medium	Matte	Winchester 70



# ROCK-SOLID, EASY-TO-INSTALL SHOTGUN MOUNTS.

## SEE-THRU SADDLE MOUNTS

Millett® saddle mounts are easy to install, provide a rock-solid foundation for your scope or red dot sight, and are custom-styled for your shotgun. The lines are smooth and trim, with every bit of excess bulk removed.

### NEW Picatinny Shotgun Rail

ITEM	DESCRIPTION
PC00107	Remington 870, pre-tapped receivers
PC00108	Mossberg 500, pre-tapped receivers



### Shotgun Saddle Mounts

DESCRIPTION	PART NUMBER
Remington 870, 1100, 1187, 12GA.	SE00020
Remington 870, 1100, 1187, 20GA.	SE00045
Winchester 1300 12GA.	SE00021
Winchester 1400, 1500 12GA.	SE00023
Mossberg 500, 835, 12 GA.	SE00022
Mossberg 9200 12GA.	SE00044



## SCOPE TO IRON SIGHTS AND BACK, NO PROBLEM

### SEE-THRU SCOPE MOUNTS

Millett See-Thru Scope Mounts are machined from aircraft quality aluminum material to the tightest tolerances. Instead of simply being machined to fit a particular receiver's contour, all Millett See-Thru mounts feature our exclusive Sure-Fit™ Contact Rails. This unique three-point design accommodates any slight variation in the radius of the receiver, and provides the most rigid and accurate mounting system available.

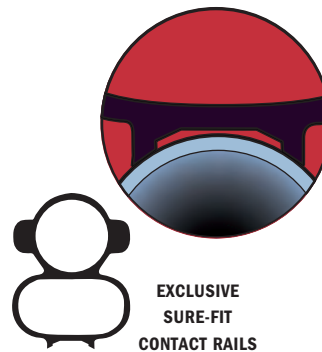

### See-Thru Scope Mounts

MAKE & MODEL	SMOOTH	MATTE
Fits Weaver-Style Bases	SE00030	SE00730
.22 Cal Rings	SE00014	SE00714
Remington 700, 721, 722, 725	SE00701	
Remington 740, 742, 760, SAV 170	SE00707	
Remington 7400, 7600, 4, 6	SE00008	SE00708



COMBINING FAST TARGET ACQUISITION WITH PRECISION SIGHTING, THESE MILLETT SEE THROUGH MOUNTS OFFER THE MOST IN VERSATILITY FOR THE HUNTER



## SMALL RING, BIG HOLD

### HANDGUN MOUNTS

Millett® handgun mounts, engineered with an exceptionally solid durability, are a rugged, lightweight way to add an optical edge to your accuracy.

#### Ruger Super Redhawk Handgun Mounts

ITEM	DIAMETER	DESCRIPTION	FINISH
RR77004	1"	Med	Smooth
RR77006	30MM	Med	Smooth
PR00010	Base Only	Double Dovetail	Smooth
RR00011	Base Only	Angle-Loc™	Smooth
TP00709	1"	Med	Matte
TP00710	30MM	Med (.22 Cal)	Matte

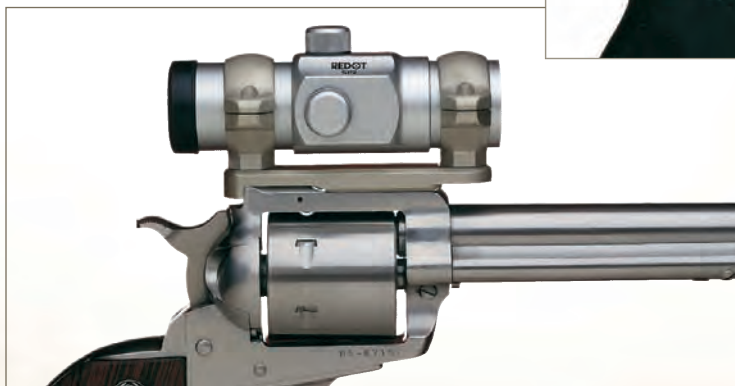

COLT ANACONDA & PYTHON MOUNT.  
DRILLING AND TAPPING REQUIRED.

RUGER BLACKHAWK, REDHAWK,  
SUPER BLACKHAWK, GP 100 MOUNT

SEE-THRU & HANDGUN MOUNTS